

User's Manual



FOX 500 DA6 High Resolution Fiber Optic Transmitter/Distribution Amplifier

68-1363-01 **Rev. A**
11 07



www.extron.com

Extron Electronics, USA
1230 South Lewis Street
Anaheim, CA 92805
800.633.9876 714.491.1500
FAX 714.491.1517

Extron Electronics, Europe
Beeldschermweg 6C
3821 AH Amersfoort, The Netherlands
+800.3987.6673 +31.33.453.4040
FAX +31.33.453.4050

Extron Electronics, Asia
135 Joo Seng Rd. #04-01
PM Industrial Bldg., Singapore 368363
+800.7339.8766 +65.6383.4400
FAX +65.6383.4664

Extron Electronics, Japan
Kyodo Building, 16 Ichibancho
Chiyoda-ku, Tokyo 102-0082
Japan
+81.3.3511.7655 FAX +81.3.3511.7656

Precautions

Safety Instructions • English



This symbol is intended to alert the user of important operating and maintenance (servicing) instructions in the literature provided with the equipment.



This symbol is intended to alert the user of the presence of uninsulated dangerous voltage within the product's enclosure that may present a risk of electric shock.

Caution

Read Instructions • Read and understand all safety and operating instructions before using the equipment.

Retain Instructions • The safety instructions should be kept for future reference.

Follow Warnings • Follow all warnings and instructions marked on the equipment or in the user information.

Avoid Attachments • Do not use tools or attachments that are not recommended by the equipment manufacturer because they may be hazardous.

Consignes de Sécurité • Français



Ce symbole sert à avertir l'utilisateur que la documentation fournie avec le matériel contient des instructions importantes concernant l'exploitation et la maintenance (réparation).



Ce symbole sert à avertir l'utilisateur de la présence dans le boîtier de l'appareil de tensions dangereuses non isolées posant des risques d'électrocution.

Attention

Lire les instructions • Prendre connaissance de toutes les consignes de sécurité et d'exploitation avant d'utiliser le matériel.

Conservier les instructions • Ranger les consignes de sécurité afin de pouvoir les consulter à l'avenir.

Respecter les avertissements • Observer tous les avertissements et consignes marqués sur le matériel ou présents dans la documentation utilisateur.

Eviter les pièces de fixation • Ne pas utiliser de pièces de fixation ni d'outils non recommandés par le fabricant du matériel car cela risquerait de poser certains dangers.

Sicherheitsanleitungen • Deutsch



Dieses Symbol soll dem Benutzer in der im Lieferumfang enthaltenen Dokumentation besonders wichtige Hinweise zur Bedienung und Wartung (Instandhaltung) geben.



Dieses Symbol soll den Benutzer darauf aufmerksam machen, daß im Inneren des Gehäuses dieses Produktes gefährliche Spannungen, die nicht isoliert sind und die einen elektrischen Schock verursachen können, herrschen.

Achtung

Lesen der Anleitungen • Bevor Sie das Gerät zum ersten Mal verwenden, sollten Sie alle Sicherheits- und Bedienungsanleitungen genau durchlesen und verstehen.

Aufbewahren der Anleitungen • Die Hinweise zur elektrischen Sicherheit des Produktes sollten Sie aufbewahren, damit Sie im Bedarfsfall darauf zurückgreifen können.

Befolgen der Warnhinweise • Befolgen Sie alle Warnhinweise und Anleitungen auf dem Gerät oder in der Benutzerdokumentation.

Keine Zusatzgeräte • Verwenden Sie keine Werkzeuge oder Zusatzgeräte, die nicht ausdrücklich vom Hersteller empfohlen wurden, da diese eine Gefahrenquelle darstellen können.

Instrucciones de seguridad • Español



Este símbolo se utiliza para advertir al usuario sobre instrucciones importantes de operación y mantenimiento (o cambio de partes) que se desean destacar en el contenido de la documentación suministrada con los equipos.



Este símbolo se utiliza para advertir al usuario sobre la presencia de elementos con voltaje peligroso sin protección aislante, que puedan encontrarse dentro de la caja o alojamiento del producto, y que puedan representar riesgo de electrocución.

Precaución

Leer las instrucciones • Leer y analizar todas las instrucciones de operación y seguridad, antes de usar el equipo.

Conservar las instrucciones • Conservar las instrucciones de seguridad para futura consulta.

Obedecer las advertencias • Todas las advertencias e instrucciones marcadas en el equipo o en la documentación del usuario, deben ser obedecidas.

Evitar el uso de accesorios • No usar herramientas o accesorios que no sean específicamente recomendados por el fabricante, ya que podrían implicar riesgos.

Warning

Power sources • This equipment should be operated only from the power source indicated on the product. This equipment is intended to be used with a main power system with a grounded (neutral) conductor. The third (grounding) pin is a safety feature, do not attempt to bypass or disable it.

Power disconnection • To remove power from the equipment safely, remove all power cords from the rear of the equipment, or the desktop power module (if detachable), or from the power source receptacle (wall plug).

Power cord protection • Power cords should be routed so that they are not likely to be stepped on or pinched by items placed upon or against them.

Servicing • Refer all servicing to qualified service personnel. There are no user-serviceable parts inside. To prevent the risk of shock, do not attempt to service this equipment yourself because opening or removing covers may expose you to dangerous voltage or other hazards.

Slots and openings • If the equipment has slots or holes in the enclosure, these are provided to prevent overheating of sensitive components inside. These openings must never be blocked by other objects.

Lithium battery • There is a danger of explosion if battery is incorrectly replaced. Replace it only with the same or equivalent type recommended by the manufacturer. Dispose of used batteries according to the manufacturer's instructions.

Avertissement

Alimentations • Ne faire fonctionner ce matériel qu'avec la source d'alimentation indiquée sur l'appareil. Ce matériel doit être utilisé avec une alimentation principale comportant un fil de terre (neutre). Le troisième contact (de mise à la terre) constitue un dispositif de sécurité : n'essayez pas de la contourner ni de la désactiver.

Déconnexion de l'alimentation • Pour mettre le matériel hors tension sans danger, déconnectez tous les cordons d'alimentation de l'arrière de l'appareil ou du module d'alimentation de bureau (s'il est amovible) ou encore de la prise secteur.

Protection du cordon d'alimentation • Acheminer les cordons d'alimentation de manière à ce que personne ne risque de marcher dessus et à ce qu'ils ne soient pas écrasés ou pincés par des objets.

Réparation-maintenance • Faire exécuter toutes les interventions de réparation-maintenance par un technicien qualifié. Aucun des éléments internes ne peut être réparé par l'utilisateur. Afin d'éviter tout danger d'électrocution, l'utilisateur ne doit pas essayer de procéder lui-même à ces opérations car l'ouverture ou le retrait des couvercles risquent de l'exposer à de hautes tensions et autres dangers.

Fentes et orifices • Si le boîtier de l'appareil comporte des fentes ou des orifices, ceux-ci servent à empêcher les composants internes sensibles de surchauffer. Ces ouvertures ne doivent jamais être bloquées par des objets.

Lithium Batterie • Il a danger d'explosion s'il y a remplacement incorrect de la batterie. Remplacer uniquement avec une batterie du même type ou d'un type équivalent recommandé par le constructeur. Mettre au rebut les batteries usagées conformément aux instructions du fabricant.

Vorsicht

Stromquellen • Dieses Gerät sollte nur über die auf dem Produkt angegebene Stromquelle betrieben werden. Dieses Gerät wurde für eine Verwendung mit einer Hauptstromleitung mit einem geerdeten (neutralen) Leiter konzipiert. Der dritte Kontakt ist für einen Erdschluss, und stellt eine Sicherheitsfunktion dar. Diese sollte nicht umgangen oder außer Betrieb gesetzt werden.

Stromunterbrechung • Um das Gerät auf sichere Weise vom Netz zu trennen, sollten Sie alle Netzkabel aus der Rückseite des Gerätes, aus der externen Stromversorgung (falls dies möglich ist) oder aus der Wandsteckdose ziehen.

Schutz des Netzkabels • Netzkabel sollten stets so verlegt werden, daß sie nicht im Weg liegen und niemand darauf treten kann oder Objekte darauf- oder unmittelbar dagegen gestellt werden können.

Wartung • Alle Wartungsmaßnahmen sollten nur von qualifiziertem Servicepersonal durchgeführt werden. Die internen Komponenten des Gerätes sind wartungsfrei. Zur Vermeidung eines elektrischen Schocks versuchen Sie in keinem Fall, dieses Gerät selbst öffnen, da beim Entfernen der Abdeckungen die Gefahr eines elektrischen Schlags und/oder andere Gefahren bestehen.

Schlitze und Öffnungen • Wenn das Gerät Schlitze oder Löcher im Gehäuse aufweist, dienen diese zur Vermeidung einer Überhitzung der empfindlichen Teile im Inneren. Diese Öffnungen dürfen niemals von anderen Objekten blockiert werden.

Lithium-Batterie • Explosionsgefahr, falls die Batterie nicht richtig ersetzt wird. Ersetzen Sie verbrauchte Batterien nur durch den gleichen oder einen vergleichbaren Batterietyp, der auch vom Hersteller empfohlen wird. Entsorgen Sie verbrauchte Batterien bitte gemäß den Herstelleranweisungen.

Advertencia

Alimentación eléctrica • Este equipo debe conectarse únicamente a la fuente/tipo de alimentación eléctrica indicada en el mismo. La alimentación eléctrica de este equipo debe provenir de un sistema de distribución general con conductor neutro a tierra. La tercera pata (puesta a tierra) es una medida de seguridad, no puentearla ni eliminarla.

Desconexión de alimentación eléctrica • Para desconectar con seguridad la acometida de alimentación eléctrica al equipo, desenchufar todos los cables de alimentación en el panel trasero del equipo, o desenchufar el módulo de alimentación (si fuera independiente), o desenchufar el cable del receptáculo de la pared.

Protección del cables de alimentación • Los cables de alimentación eléctrica se deben instalar en lugares donde no sean pisados ni apretados por objetos que se puedan apoyar sobre ellos.

Reparaciones/mantenimiento • Solicitar siempre los servicios técnicos de personal calificado. En el interior no hay partes a las que el usuario deba acceder. Para evitar riesgo de electrocución, no intentar personalmente la reparación/mantenimiento de este equipo, ya que al abrir o extraer las tapas puede quedar expuesto a voltajes peligrosos u otros riesgos.

Ranuras y aberturas • Si el equipo posee ranuras o orificios en su caja/alojamiento, es para evitar el sobrecalentamiento de componentes internos sensibles. Estas aberturas nunca se deben obstruir con otros objetos.

Batería de litio • Existe riesgo de explosión si esta batería se coloca en la posición incorrecta. Cambiar esta batería únicamente con el mismo tipo (o su equivalente) recomendado por el fabricante. Desachar las baterías usadas siguiendo las instrucciones del fabricante.

Extron's Warranty

Extron Electronics warrants this product against defects in materials and workmanship for a period of three years from the date of purchase. In the event of malfunction during the warranty period attributable directly to faulty workmanship and/or materials, Extron Electronics will, at its option, repair or replace said products or components, to whatever extent it shall deem necessary to restore said product to proper operating condition, provided that it is returned within the warranty period, with proof of purchase and description of malfunction to:

USA, Canada, South America, and Central America:

Extron Electronics
1001 East Ball Road
Anaheim, CA 92805, USA

Asia:

Extron Electronics, Asia
135 Joo Seng Road, #04-01
PM Industrial Bldg.
Singapore 368363

Europe, Africa, and the Middle East:

Extron Electronics, Europe
Beeldschermweg 6C
3821 AH Amersfoort
The Netherlands

Japan:

Extron Electronics, Japan
Kyodo Building
16 Ichibancho
Chiyoda-ku, Tokyo 102-0082
Japan

This Limited Warranty does not apply if the fault has been caused by misuse, improper handling care, electrical or mechanical abuse, abnormal operating conditions or non-Extron authorized modification to the product.

If it has been determined that the product is defective, please call Extron and ask for an Applications Engineer at (714) 491-1500 (USA), 31.33.453.4040 (Europe), 65.6383.4400 (Asia), or 81.3.3511.7655 (Japan) to receive an RA# (Return Authorization number). This will begin the repair process as quickly as possible.

Units must be returned insured, with shipping charges prepaid. If not insured, you assume the risk of loss or damage during shipment. Returned units must include the serial number and a description of the problem, as well as the name of the person to contact in case there are any questions.

Extron Electronics makes no further warranties either expressed or implied with respect to the product and its quality, performance, merchantability, or fitness for any particular use. In no event will Extron Electronics be liable for direct, indirect, or consequential damages resulting from any defect in this product even if Extron Electronics has been advised of such damage.

Please note that laws vary from state to state and country to country, and that some provisions of this warranty may not apply to you.

安全须知 • 中文



这个符号提示用户该设备用户手册中有重要的操作和维护说明。



这个符号警告用户该设备机壳内有暴露的危险电压，有触电危险。

注意

阅读说明书 • 用户使用该设备前必须阅读并理解所有安全和使用说明。

保存说明书 • 用户应保存安全说明书以备将来使用。

遵守警告 • 用户应遵守产品和用户指南上的所有安全和操作说明。

避免追加 • 不要使用该产品厂商没有推荐的工具或追加设备，以避免危险。

警告

电源 • 该设备只能使用产品上标明的电源。设备必须使用有地线的供电系统供电。第三条线（地线）是安全设施，不能不用或跳过。

拔掉电源 • 为安全地从设备拔掉电源，请拔掉所有设备后或桌面电源的电源线，或任何接到市电系统的电源线。

电源线保护 • 妥善布线，避免被踩踏，或重物挤压。

维护 • 所有维修必须由认证的维修人员进行。设备内部没有用户可以更换的零件。为避免出现触电危险不要自己试图打开设备盖子维修该设备。

通风孔 • 有些设备机壳上有通风槽或孔，它们是用来防止机内敏感元件过热。不要用任何东西挡住通风孔。

锂电池 • 不正确的更换电池会有爆炸的危险。必须使用与厂家推荐的相同或相近型号的电池。按照生产厂的建议处理废弃电池。

FCC Class A Notice

This equipment has been tested and found to comply with the limits for a Class A digital device, pursuant to part 15 of the FCC Rules. Operation is subject to the following two conditions: (1) this device may not cause harmful interference, and (2) this device must accept any interference received, including interference that may cause undesired operation. The Class A limits are designed to provide reasonable protection against harmful interference when the equipment is operated in a commercial environment. This equipment generates, uses, and can radiate radio frequency energy and, if not installed and used in accordance with the instruction manual, may cause harmful interference to radio communications. Operation of this equipment in a residential area is likely to cause harmful interference, in which case the user will be required to correct the interference at his own expense.

NOTE

This unit was tested with shielded cables on the peripheral devices. Shielded cables must be used with the unit to ensure compliance with FCC emissions limits.

Quick Start Guide — FOX 500 DA6

Install, connect, and operate the FOX 500 DA6 as follows:

Step 1

Turn all of the equipment off or disconnect it from the power source. If desired, mount the DA in a rack or furniture, or place it on a desktop.

Step 2

Connect a VGA to UXGA source to the DA: **either** to the RGB Input 15-pin HD connector **or** to the RGB Input BNC connectors. See the drawing at right to wire the BNC connectors.

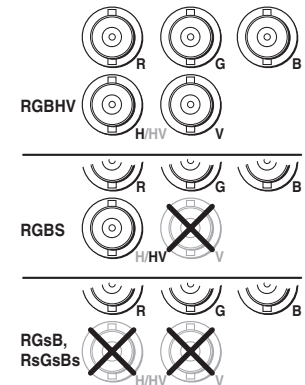

Step 3

If desired, connect a local monitor to the DA's Buffered Loop-Through 15-pin HD connector.

Step 4

Connect a balanced or unbalanced, stereo or mono audio input to the DA: **either** to the Audio Inputs 3.5 mm mini jack **or** to the Audio Inputs 5-pole captive screw connector. See the drawing at right to wire the captive screw connector.

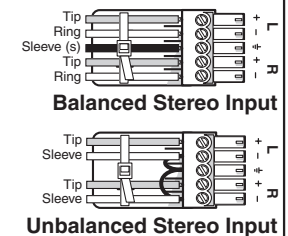

Step 5

If you want the DA to pass serial signals, such as for serial control of a projector, connect the master device to the DA and the slave device(s) to the receiver(s) via three poles of the RS-232 Over Fiber captive screw connectors on all units.

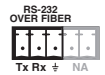

NOTE For RS-232 responses (from the master receiver to the DA), you must install fiber cable Optical 2. See Step 9.

Step 6

For serial control of the DA and receiver, connect a host device to either unit via three poles of the Remote RS-232/Alarm captive screw connector or to either unit's front panel Configuration connector.

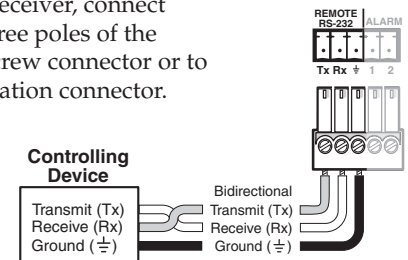

Quick Start Guide — FOX 500 DA6 cont'd

Step 7

For remote monitoring of the status of the Optical 2 link from the master receiver, connect a locally constructed or obtained device to the two Alarm poles of the DA's RS-232/Alarm 5-pole captive screw connector. The DA shorts the two poles together when no light is detected.



NOTE The DA's Alarm port reports the status of the Optical 2 light link.

Step 8

Connect up to six Optical 1 (required) fiber cables between the DA and receiver(s).

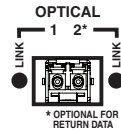

Step 9

If desired, connect the optional Optical 2 fiber cable between the DA output 1 and the master receiver.

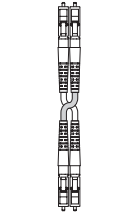

NOTE Optical 2 is functional only for output 1.

Only Optical 1 is required for video, audio, and serial command transmission. Optical 2 is required only to send serial data (such as commands from the master receiver to the DA and passed responses from the controlled device (such as a projector) to the controlling device.

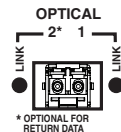

Step 10

Connect 1 or 2 RGBHV, RGBS, or RGSB displays to the receiver(s): to the RGB Output 15-pin HD connector and/or to the RGB Outputs BNC connectors.

Step 11

Use the receiver(s)' Alt. Pixels test pattern to set each display's total pixel and phase for the best picture.

Step 12

Connect balanced or unbalanced stereo or mono audio devices to the receiver(s): to the Audio Outputs 3.5 mm mini jack and/or to the Audio Outputs 5-pole captive screw connector.



Balanced Stereo Output

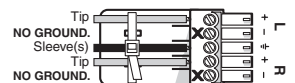

Unbalanced Stereo Output

CAUTION Connect the sleeve to ground (Gnd). Connecting it to a negative (-) terminal will damage the audio output circuits.

Chapter One • Introduction	1-1
About this Manual	1-2
About the FOX 500 DA6	1-2
Features	1-4
Chapter Two • Installation and Operation	2-1
Mounting the Unit	2-2
Tabletop placement	2-2
Rack mounting	2-2
UL requirements	2-2
Mounting instructions	2-3
Furniture mounting the DA	2-3
Connections	2-4
Transmitter rear panel connections	2-4
Rear panel serial ports connection	2-8
Alarm outputs connection	2-9
Front panel Configuration port	2-9
Front Panel Indicators	2-11
System Operation	2-12
Chapter Three • Remote Control	3-1
Rear Panel Remote RS-232 Ports	3-2
Front Panel Configuration Port	3-3
Simple Instruction Set Control	3-3
Host-to-interface communications	3-3
Symbol definitions	3-3
Unit-initiated messages	3-5
Front panel operations	3-5
Error responses	3-7
Timeout	3-7
Using the command/response table	3-7
Command/response table fro SIS commands	3-8

Table of Contents, cont'd

Windows®-based Program Control.....	3-16
Installing the software	3-16
Starting the program.....	3-16
Status area	3-18
Memory Preset area	3-18
Mute area.....	3-19
Video Adjustment area	3-20
Output Configuration area	3-20
Advanced Configuration area	3-21
Audio Adjustment area.....	3-22
Audio Output Level area.....	3-22
Firmware upgrade	3-23
Appendix A • Reference Information.....	A-1
Specifications	A-2
Part Numbers	A-6
FOX 500 DA6 part numbers.....	A-6
Included parts.....	A-6
Compatible equipment.....	A-6
Optional accessory.....	A-7
Cables.....	A-7



FOX 500 DA6

Chapter One

Introduction

About this Manual

About the FOX 500 DA6

Features

68-1363-01 Rev. A
11 07

All trademarks mentioned in this manual are the properties of their respective owners.

Introduction

WARNING The FOX 500 DA6 outputs continuous invisible light, which may be harmful and dangerous to the eyes; use with caution.

- Do not look into the rear panel fiber optic cable connectors or into the fiber optic cables themselves.
- Plug the attached dust caps into the optical transceivers when the fiber optic cable is unplugged.

About this Manual

This manual contains information about the following Extron FOX 500 DA6 fiber optic transmitting distribution amplifier products:

- FOX 500 DA6 MM — A multimode, long distance (up to 150 m [450']) distribution amplifier
- FOX 500 DA6 SM — A singlemode, very long distance (up to 30 km [18.75 miles]) distribution amplifier

NOTE The two products are physically and functionally identical, with the exception of the effective range of transmission. In this manual, the terms "FOX 500 DA6" and "DA" refer to either product.

NOTE Many products are compatible with the Extron FOX 500 distribution amplifier. They are identified where appropriate, but not specifically described in this manual.

About the FOX 500 DA6

The Extron FOX 500 DA6 (figure 1-1) product family consists of two models of ultra-high performance RGB video, audio, and RS-232 serial communications fiber optic distribution amplifiers.

The DA inputs VGA - UXGA RGB video, audio, and one-way (DA-to-receiver) RS-232 communications (for applications such as projector control); converts them to a proprietary signal; and outputs the signal on up to six fiber optic cables to compatible receiver(s). An optional return (receiver-to-DA) stream of serial RS-232 communications, such as projector responses, requires a second fiber optic cable.

NOTE The six optical outputs are identical.

NOTE The return (receiver-to-DA) stream can come only from the device connected to output 1. In this manual, this device is called "the master receiver".

Both fiber cables must be connected to output 1 to support the return stream from the master receiver.

When both optical cables are connected between the DA and the master receiver, any changes made using the master receiver's menu system are applied to all other connected receivers.

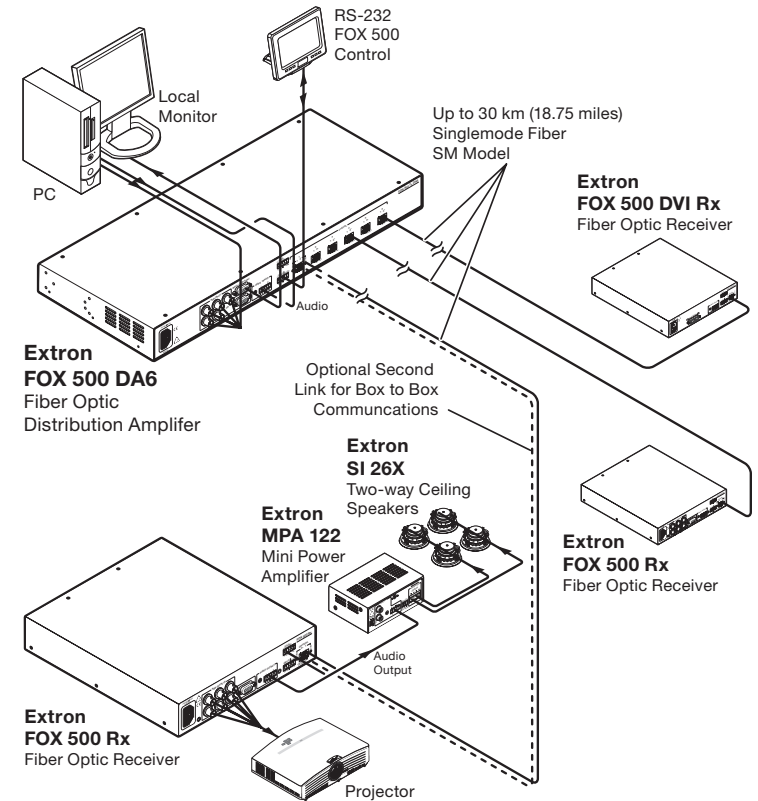

Figure 1-1 — Typical FOX 500 DA6 application

The DA also buffers the RGB input and loops it through on a 15-pin HD connector for use by a local monitor. The DA can handle an RGBHV, RGBS, RGsB, or RsGsBs input signal.

NOTE *The DA can send and receive the proprietary signal(s) to and from any compatible Extron receiver or switcher. These compatible products include the FOX 500 Rx (RGB) receiver, the FOX 500 Rx DVI receiver, and the Fiber Matrix 6400 matrix switcher.*

The connected receiver(s) convert the proprietary signal(s) back to video (either RGB or DVI, depending on the receiver), audio, and serial RS-232 communication, and output the signals locally. If RS-232 return communications are implemented (a second fiber optic cable is installed), the receiver connected to DA output 1 sends a proprietary serial communication signal back to the DA on the second fiber optic cable. For video resolutions up to 1600 x 1200, the receivers' video outputs are a perfect pixel-for-pixel or digital recreation of the video signal input to the DA.

The receivers have image and audio adjustments and test patterns that can be set locally or via an RS-232 link and sent to the DA, which, in turn, sends them to the transmitter on the fiber link. The transmitter has image, audio, and fiber light status and lost-light alarm indicators.

The FOX 500 DA is rack mountable and has an internal switching power supply for worldwide power compatibility.

Features

Ultra high performance — Offers up to six perfect, pixel-by-pixel, RGBHV video transmissions to compatible receiver(s). The DA can handle resolutions up to 1600 x 1200 at 60 Hz. Higher resolutions can be transmitted, but with some loss of video quality and undersampled.

Video input — The DA inputs RGBHV, RGBS, RGsB, or RsGsBs on BNC connectors or a 15-pin HD connector.

Six active and individually isolated outputs — The FOX 500 DA6 uses active signal splitting to maintain equal transmitter power to all outputs, maximizing distance capabilities by ensuring full availability of optical loss budget for each output.

Analog loop-through on DA — The DA has an analog loop-through on a 15-pin HD connector that allows connection of a local monitor.

System video output — The video portion of the optical video output can be decoded to either RGB video or DVI video, depending on the receiver connected.

Audio input — The DA inputs balanced or unbalanced stereo audio on a 3.5 mm, 5-pole captive screw terminal or a 3.5 mm mini jack.

Audio input gain/attenuation — The input audio level can be adjusted within a range of -18 dB attenuation to +10 dB gain via the master receiver's front panel or the RS-232 link.

Links monitoring — The front panel has indicators for monitoring image and audio transmission and both fiber optic links.

Loss-of-light alarms — The rear panel has discrete outputs that indicate if either of the fiber optic links have suffered a loss of the light signal.

Windows-based control program — For RS-232 remote control from a PC, the Extron Windows®-based control software provides a graphical interface and drag-and-drop/point-and-click operation.

Simple Instruction Set (SIS™) — The DA uses Extron's SIS for easy remote control operation.

Upgradable firmware — The firmware that controls the unit's operation can be upgraded in the field via an RS-232 link, without taking the unit out of service. Firmware upgrades are available for download on the Extron Web site, www.extron.com, and they can be installed using the Windows-based control program.

Memory presets — 30 memory presets are a time-saving feature that lets you store input size and position settings relative to a specific input resolution. You can then recall those settings, when needed, with a few simple steps via the master receiver's front panel or the RS-232 link.

Rack mounting — The unit is rack mountable in any conventional 19" wide rack, using the included rack mounting brackets.

Power — The 100 VAC to 240 VAC, internal power supply provides worldwide power compatibility.



Chapter Two

Installation and Operation

Mounting the Unit

Connections

Front Panel Indicators

System Operation

Installation and Operation

Mounting the Unit

CAUTION *Installation and service must be performed by authorized personnel only.*

The 1U high, full-rack width unit can be placed on a tabletop, mounted in a rack, or mounted under or through a desk or other furniture.

Tabletop placement

Affix the four included rubber feet to the bottom of the unit and place it in any convenient location.

Rack mounting

UL requirements

The following Underwriters Laboratories (UL) requirements pertain to the installation of the FOX 500 DA6 into a rack (figure 2-1).

1. **Elevated operating ambient** — If installed in a closed or multi-unit rack assembly, the operating ambient temperature of the rack environment may be greater than room ambient. Therefore, consider installing the equipment in an environment compatible with the +122 °F (+50 °C) maximum ambient temperature (T_{ma}) specified by the manufacturer.
2. **Reduced air flow** — Installation of the equipment in a rack should be such that the amount of air flow required for safe operation of the equipment is not compromised.
3. **Mechanical loading** — Mounting of the equipment in the rack should be such that a hazardous condition is not achieved due to uneven mechanical loading.
4. **Circuit overloading** — Consideration should be given to the connection of the equipment to the supply circuit and the effect that overloading of the circuits might have on overcurrent protection and supply wiring. Appropriate consideration of equipment nameplate ratings should be used when addressing this concern.
5. **Reliable earthing (grounding)** — Reliable earthing of rack-mounted equipment should be maintained. Particular attention should be given to supply connections other than direct connections to the branch circuit (such as the use of power strips).

Mounting instructions

Rack mount the DA as follows:

1. Attach the rack mounting brackets to the DA with the supplied eight #8 machine screws (figure 2-1).
2. Insert the DA into the rack, aligning the holes in the mounting bracket with those in the rack.

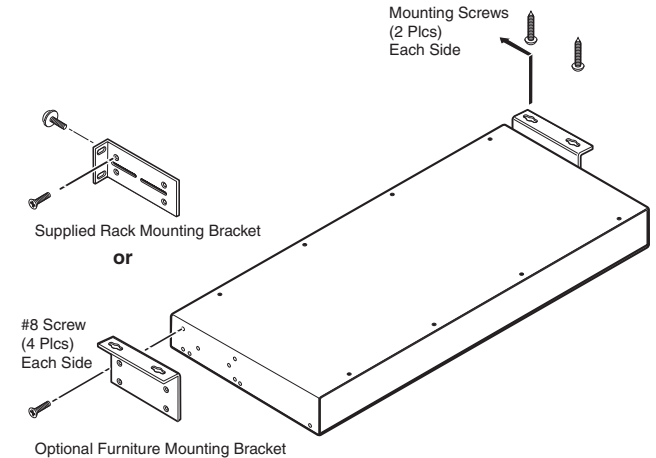

Figure 2-1 — Mounting the DA

3. Secure the DA to the rack using the supplied machine screws.

Furniture mounting the DA

Mount the DA under a table or other horizontal surface with an optional Extron MBU 149 1U full rack under-desk mounting kit (part #70-222-01) as follows:

1. Secure the two table/wall mounting brackets to the unit with the eight machine screws provided in the kit (figure 2-1).
2. Hold the unit with attached brackets against the underside of the desk or other furniture. Mark the location of holes for screws on the underside of the desk.
3. Drill 1/4" (6.4 mm) deep, 3/32" (2 mm) diameter pilot holes in the table or desk at the marked screw locations from the underside or inside (concealed side) of the furniture, where the DA will be located.
4. Insert the four wood screws into the pilot holes. Fasten each screw into the installation surface until just less than 1/4" of the screw head protrudes.

Installation and Operation, cont'd

- Align the installed screws with the slots in the mounting brackets, and place the unit against the surface, with the screws through the bracket slots.
- Slide the unit slightly forward or back, then tighten all four screws to fasten it in place.

Connections

All connectors except the Configuration port are on the rear panel (figure 2-2 and figure 2-5).

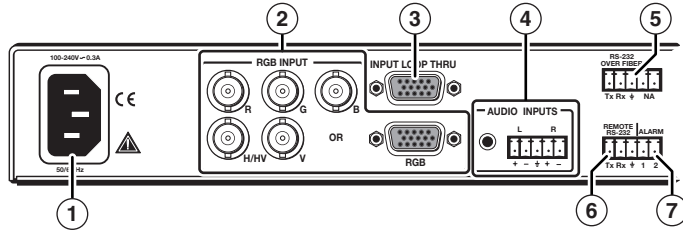

Figure 2-2 — DA's connectors, left side

- AC power connector** — Plug a standard IEC power cord into this connector to connect the DA to a 100 VAC to 240 VAC, 50 or 60 Hz power source.
- RGB Input connectors** —

NOTE Connect an active input to **only** the BNC connectors or the 15-pin HD connector, **not both**.

BNC connectors — Connect an RGBHV, RGBS, RGsB, or RsGsBs video source to these BNC connectors. Connect the cables as shown at right.

15-pin HD connector — Connect an analog VGA - UXGA RGB video source to this 15-pin HD female connector.

- Buffered Loop-through connector** — If desired, connect a local monitor to this 15-pin HD connector.

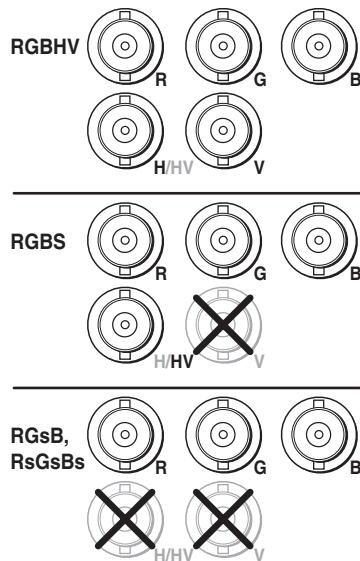

- Audio Input connectors** —

3.5 mm mini jack — Plug a stereo mini plug into this connector.

5-pole captive screw connector — Connect a balanced or unbalanced stereo or mono audio input to this connector. The connector is included with FOX 500, but you must supply the audio cable. See figure 2-3 to wire a captive screw connector for the appropriate input type and impedance level. Use the supplied tie-wrap to strap the audio cable to the extended tail of the connector.

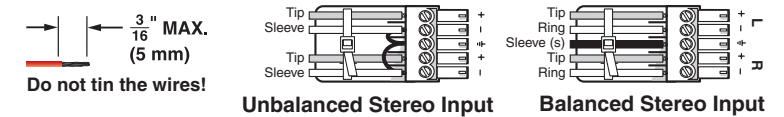

Figure 2-3 — Captive screw connector wiring for stereo audio input

NOTE The length of exposed wires is critical. The ideal length is 3/16" (5 mm).

- If the stripped section of wire is longer than 3/16", the exposed wires may touch, causing a short circuit between them.
- If the stripped section of wire is shorter than 3/16", wires can be easily pulled out even if tightly fastened by the captive screws.

NOTE See figure 2-4 to identify the tip, ring, and sleeve when you are making connections for the DA from existing audio cables. A mono audio connector consists of the tip and sleeve. A stereo audio connector consists of the tip, ring, and sleeve. The ring, tip, and sleeve wires are also shown on the captive screw audio connector diagram, figure 2-3.

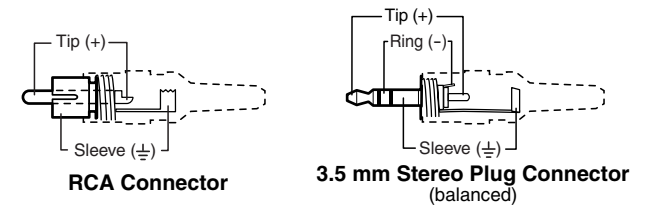
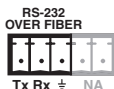

Figure 2-4 — Typical audio connectors

The input's audio level can be individually set via the master receiver's front panel or RS-232 control. Refer to the *FOX 500 Tx/Rx* manual and see chapter 3, "Remote Control" in this manual.

- ⑤ **RS-232 Over Fiber port** — If you want the FOX 500 to pass serial command signals to the receiver(s) (for serial control of a projector, for example), connect the host device to the DA via the left three poles of this 5-pole captive screw connector. See "Rear panel serial ports connection" on page 2-8 to wire this connector.



NOTE If you connect only one fiber optic cable (item ⑧, on the next page), you do not receive reports from the controlled device connected to the master receiver. To receive responses from the controlled device, you must install two fiber optic cables.

NOTE The FOX 500 can pass RS-232 commands and responses at rates up to 38400 baud.

- ⑥ **Remote RS-232 port** — For serial control of the DA, connect a host device, such as a computer, touch panel control, or RS-232 capable PDA, to the DA via the left three poles of this 5-pole captive screw connector. See "Rear panel serial ports connection" on page 2-8 to wire this connector.

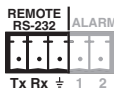

See chapter 3, "Remote Control", for definitions of the SIS commands (serial commands to control the DA via this connector).

- ⑦ **Alarm outputs port** — For remote monitoring of the status of fiber optic link 2 from the master receiver, connect a locally-constructed or furnished device to the DA via the right two poles of this 5-pole captive screw connector. When the DA does not detect a light link on fiber cable Optical 2 (optional) of output 1, it shorts pin 1 and pin 2 of this port together.

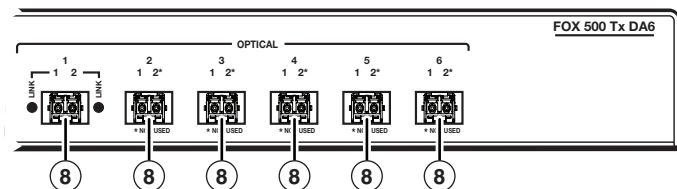

Figure 2-5 — DA's connectors, right side

- ⑧ **Fiber optic connectors and LED** —

WARNING These units output continuous invisible light, which may be harmful and dangerous to the eyes; use with caution. For additional safety, plug the attached dust caps into the optical transceivers when the fiber optic cable is unplugged.

NOTE Singlemode and multimode devices are **not** interchangeable. Ensure that you connect receiving devices that are compatible with the DA.

NOTE Ensure that you use the proper fiber cable for your DA/receiver pair. Typically, singlemode fiber has a yellow jacket and multimode cable has an orange jacket.

NOTE Only one fiber optic cable, Optical 1, is required for video, audio, and serial command transmission. But, if you connect only one fiber optic cable, you do **not** receive RS-232 communications from the controlled device connected to the master receiver, and there is **reduced** RS-232 command and Windows control program functionality on the receiver. To receive responses from the master receiver and for full functionality, you must install both fiber optic cables between the DA and the master receiver.

Optical 1 — For all one-way video, audio, and serial communications from the DA to the receiver, connect a fiber optic cable to the Optical 1 LC connector.

Connect the free end of this fiber optic cable to the Optical 1 connector on the receiver or other compatible Extron device.

Optical 2 — For all one-way serial communications from the master receiver to the DA, connect a fiber optic cable to the Optical 2 LC connector.

Connect the free end of this fiber optic cable to the Optical 2 connector on the receiver connected to DA output 1 or to any other compatible device.

NOTE Optical 2 is functional only for output 1.

Link 1 and Link 2 LEDs — When lit, the link is active (light is received).

NOTE The Link 1 and Link 2 LEDs are present only for output 1.

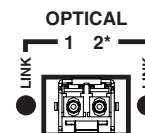

* OPTIONAL FOR RETURN DATA

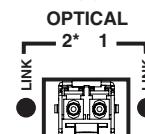
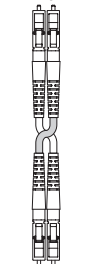

* OPTIONAL FOR RETURN DATA

Rear panel serial ports connection

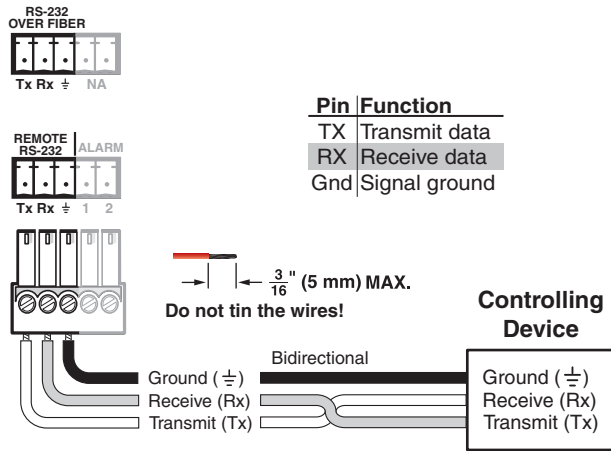

Figure 2-6 — RS-232 connectors

NOTE The RS-232 Over Fiber port is for transmission of serial signals, such as projector control signals, between the DA and receiver.
The Remote RS-232 port is for remote control of the DA and receiver.

NOTE The length of exposed wires is critical. The ideal length is 3/16" (5 mm).

- If the stripped section of wire is longer than 3/16", the exposed wires may touch, causing a short circuit between them.
- If the stripped section of wire is shorter than 3/16", wires can be easily pulled out even if tightly fastened by the captive screws.

NOTE The rear panel Remote RS-232 port is active only if the front panel Configuration port is not in use. If a front panel configuration connection is made, the Remote RS-232 port becomes inactive and the front panel Configuration port is active.

Alarm outputs connection

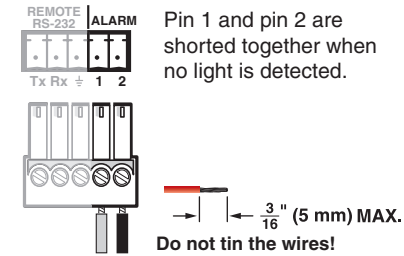

Figure 2-7 — Alarms connector

NOTE The length of exposed wires is critical. The ideal length is 3/16" (5 mm).

- If the stripped section of wire is longer than 3/16", the exposed wires may touch, causing a short circuit between them.
- If the stripped section of wire is shorter than 3/16", wires can be easily pulled out even if tightly fastened by the captive screws.

Front panel Configuration port



Figure 2-8 — FOX 500 DA6 front panel

NOTE This port is for remote control of the DA or the receiver(s), *not* for the over fiber RS-232 link.

- ⑨ **Configuration port** — This 2.5 mm mini stereo jack serves the same serial communications function as the rear panel Remote RS-232 port, but is easier to access than the rear port after the unit has been installed and cabled. The optional 9-pin D to 2.5 mm mini jack TRS RS-232 cable, part #70-335-01 (figure 2-9), can be used for this connection.

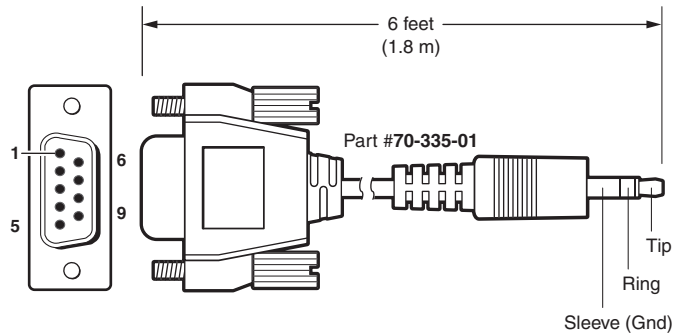

9-pin D	Connection	TRS Plug
Pin 2	Computer's RX line	Tip
Pin 3	Computer's TX line	Ring
Pin 5	Computer's signal ground	Sleeve

Figure 2-9 — Optional 9-pin TRS RS-232 cable

NOTE This port parallels the rear panel Remote RS-232 ports. If a front panel configuration connection is made, the rear panel Remote RS-232 port becomes inactive and the front panel Configuration port is active.

This port is RS-232 only, with the following protocols:

- 9600 baud
- no parity
- 8 data bits
- 1 stop bit
- no flow control

NOTE The maximum distances from the DA or receiver to the controlling device can vary up to 200' (61 m). Factors such as cable gauge, baud rates, environment, and output levels (from the unit and the controlling device) all affect transmission distance. Distances of about 50' (15 m) are typically not a problem. In some cases, the unit may be capable of serial communications via RS-232 up to 250' (76 m) away.

Front Panel Indicators

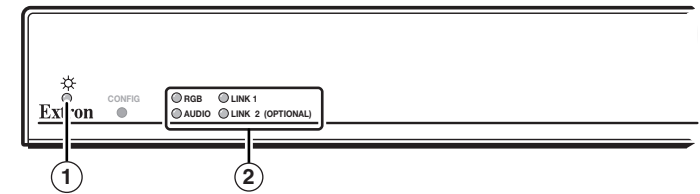

Figure 2-10 — DA indicators

① **Power LED** — This LED lights to indicate the power is applied to the unit.

② **Signal monitoring LEDs** —

RGB LED — This LED lights on both units when the DA detects a sync signal on its video input:

- Horizontal sync (H) (for RGBHV video)
- Composite sync (S) (for RGBS video)
- Green (Sync on green) (G) (for RGSB or RsGsBs video)

Audio LED — This LED lights when the DA detects a low level audio signal for a short period of time. This LED goes dark if the audio signal drops below the minimum threshold for a short period of time.

Link 1 LED — This LED lights when the master receiver detects light on the fiber optic cable Optical 1 **and** the fiber optic cable Optical 2 is installed between the master receiver and DA output 1.

NOTE Only one fiber optic cable, Optical 1, is required for video, audio, and serial command transmission. But, if you connect only one fiber optic cable, you do **not** receive RS-232 communications from the controlled device connected to the master receiver, and there is **reduced** RS-232 command and Windows control program functionality on the receiver. To receive responses from the master receiver and for full functionality, you must install both fiber optic cables between the DA and the master receiver.

Link 2 LED — This LED lights when the DA detects light on the fiber optic cable Optical 2 connected to output 1.

System Operation

After the DA, the receiver(s), and their connected devices are powered up, the system is fully operational. If any problems are encountered, ensure all traditional and fiber cables are routed and connected properly:

- Ensure that the video source and the display(s) are properly connected to the DA and the receiver(s), and that the source, the DA, the receiver(s), and the display(s) have power applied.
- Ensure that the signal monitoring LEDs (item ② on page 2-11) are indicating correctly for your system configuration.

NOTE *If problems persist, call the Extron S3 Sales & Technical Support Hotline.*



FOX 500 DA6

Chapter Three

Remote Control

Rear Panel Remote RS-232 Ports

Front Panel Configuration Port

Simple Instruction Set Control

Windows®-Based Program Control

Remote Control

The DA has two serial ports that can be connected to a host device such as a computer running the HyperTerminal utility, an RS-232 capable PDA, or a control system. These ports make serial control of the DA and the connected receivers possible. The serial ports are:

- The rear panel Remote RS-232 port on 3-pin captive screw connectors
- The front panel Configuration (RS-232) port, a 2.5 mm mini stereo jack

The protocol for all ports is as follows:

- 9600 baud
- no parity
- 8 data bits
- 1 stop bit
- no flow control

NOTE The rear panel Remote RS-232 port is active only if the front panel Configuration port is not in use. If a front panel configuration connection is made, the rear panel Remote RS-232 port becomes inactive and the front panel Configuration port is active.

NOTE Only one fiber optic cable, Optical 1, is required for video, audio, and serial command transmission. But, if you connect only one fiber optic cable, you do **not** receive RS-232 communications from the controlled device connected to the master receiver, and there is **reduced** RS-232 command and Windows control program functionality on the receiver. To receive responses from the master receiver and for full functionality, you must install both fiber optic cables between the DA and the master receiver.

Rear Panel Remote RS-232 Ports

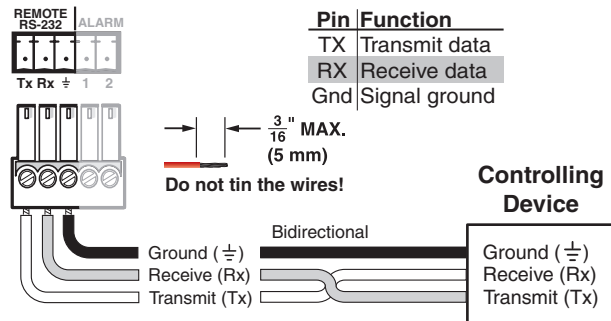
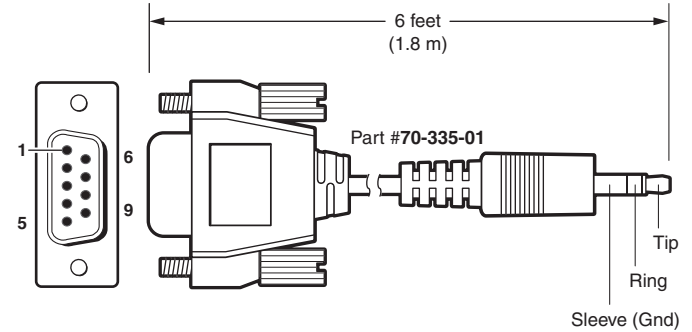

Figure 3-1 — Remote connector pin assignments

Front Panel Configuration Port

NOTE The front panel configuration ports parallel the rear panel Remote RS-232 ports. If a front panel configuration connection is made, the rear panel Remote RS-232 port becomes inactive and the front panel Configuration port is active.

The optional 9-pin D to 2.5 mm mini jack TRS RS-232 cable, part #70-335-01 (figure 3-2) can be used for connection to the Configuration port.



9-pin D	Connection	TRS Plug
Pin 2	Computer's RX line	Tip
Pin 3	Computer's TX line	Ring
Pin 5	Computer's signal ground	Sleeve

Figure 3-2 — Optional 9-pin TRS RS-232 cable

Simple Instruction Set Control

Host-to-interface communications

SIS commands consist of one or more characters per field. No special characters are required to begin or end a command character sequence. When a command is valid, the unit executes the command and sends a response to the host device. All responses from the unit to the host end with a carriage return and a line feed (CR/LF = ↵), which signals the end of the response character string. A string is one or more characters.

Symbol definitions

Symbols (variables), defined on the next page, are used throughout the "Unit-initiated messages" section and the command/response table beginning on page 3-8. The symbols represent variables in the unit-initiated messages and the command/response table fields.

Symbols

↵	= CR/LF (carriage return/line feed)	
←	= Carriage return (no line feed)	
•	= space	
X1	= Mute/auto image/front panel lock status	0 or 1 (0=off and 1=on)
X2	= Output sync format	0 = RGBHV 1 = RGsB
X3	= Output sync polarity	0 = follow input 1 = force sync to negative
X4	= Horizontal and vertical position	0 to 255
X5	= Horizontal start	0 to 255
X6	= Pixel phase	0 to 31
X7	= Total pixels	± 255 of the default value
X8	= Sync frequency	xxx.xx (frequency in kHz [H] or Hz [V])
X9	= Memory preset number	1 to 30
X10	= Audio gain adjustment range	0 to 10
X11	= Audio attenuation adjustment range	0 to -18
X12	= Audio level adjustment range	-18 to +10 (in 1.0 dB steps)
X13	= Output level	0 = consumer 1 = professional
X14	= Test pattern	0 = none 1 = Color Bars 2 = grayscale 3 = alternating pixels
X15	= Firmware version	v.vv
X16	= Link/input status	0 = link or input not sensed 1 = link or input sensed
X17	= Mode	SM = singlemode MM = multimode
X18	= Transmitter or receiver	Tx = DA Rx = receiver

NOTE The same commands and data are transmitted to all receivers through the DA's Optical 1 cables. Only the master receiver can return commands and data to the DA (via the Optical 2 cable).

NOTE Extron recommends disabling the Optical 2 output on each non-master receiver using an SIS command. This has the same affect as disconnecting the Optical 2 cable, including disabling many of the adjustments available in the receiver's menu system. Disabling these adjustments avoids confusion and/or inconsistent settings among receivers. Disabled adjustments include: total pixels, phase, horizontal start, output sync format, audio gain and attenuation, and auto image.

The "disable" SIS command (66*0*0#) can be input **only** directly to the receiver; it cannot be input via the DA. If you attempt to issue this SIS command to the DA, an E14 error code results. For this reason, the command is not documented further in this manual.

The disable is cleared when the receiver experiences a master reset.

Unit-initiated messages

When a local event, such as an error condition or a master receiver front panel operation, occurs, the unit responds by sending a message to the host. The unit-initiated messages are listed below:

(c) COPYRIGHT 2007, EXTRON ELECTRONICS FOX 500 DA6,
Vx.xx, 60-863-xx↵↵

The connected unit issues the copyright message (above) when it first powers on. Vx.xx is the firmware version number, 60-863-xx is the connected unit's part number.

Reconfig↵

The unit sends the Reconfig message whenever the video input signal to the DA is changed.

1LnkX16•2LnkX16•RGBX16•AudX16↵

The unit sends the status message whenever a change in the fiber link and video and audio connection occurs.

Front panel operations

NOTE All of the front panel operations described in this section are prompted by actions performed on the master receiver. The Optical 2 cable must be connected between the master receiver and the DA output 1 for these messages to be displayed.

HphX4↵

The unit sends the Hph message whenever the output's horizontal position is shifted from the master receiver's front panel.

VphX4↵

The unit sends the Vph message whenever the output's vertical position is shifted from the master receiver's front panel.

HstX5↵

The unit sends the Hst message whenever the output's horizontal start is shifted from the master receiver's front panel.

TpxX7←

The unit sends the Tpx message whenever the total pixels variable is changed from the master receiver's front panel.

PhsX6←

The unit sends the Phs message whenever the pixel phase variable is changed from the master receiver's front panel.

SynX3←

The unit sends the Syn message whenever the output video format is changed from the master receiver's front panel.

PolX3←

The unit sends the Pol message whenever the output sync polarity setting is changed from the master receiver's front panel.

AudX12←

The unit sends the Aud message whenever the input audio level (gain and attenuation) is changed from the master receiver's front panel.

AmtX1←

The unit sends the Amt message whenever audio output is muted or unmuted from the master receiver's front panel.

LvlX13←

The unit sends the Lvl message whenever the audio output level is changed from the master receiver's front panel.

SprX9←

The unit sends the Spr message whenever a preset is saved from the master receiver's front panel.

RprX13←

The unit sends the Rpr message whenever a preset is recalled from the master receiver's front panel.

Zpg←

The unit sends the Zpg message whenever all presets have been erased from the master receiver's front panel.

ImgX1←

The unit sends the Img message (with the X1 variable) whenever the auto memory function has been toggled on or off from the master receiver's front panel.

Img←

The unit sends the Img message (with no variable) whenever the auto image function has been triggered from the master receiver's front panel.

TstX14←

The unit sends the Tst message whenever a test pattern has been selected or test patterns are turned off from the master receiver's front panel.

Error responses

When the unit receives a valid SIS command, it executes the command and sends a response to the host device. If the unit is unable to execute the command because the command is invalid or it contains invalid parameters, the unit returns an error response to the host. The error response codes are:

E10 - Invalid command←

E11 - Invalid preset number←

E13 - Invalid parameter←

E14 - Invalid command for this configuration←

Timeout

Pauses of 10 seconds or longer between command ASCII characters result in a timeout. The command operation is aborted with no other indication.

Using the command/response table

The command/response table begins on page 3-8. Lower case letters are acceptable in the command field except where indicated for the audio level (gain and attenuation) commands. Symbols are used throughout the table to represent variables in the command/response fields. Command and response examples are shown throughout the table. The ASCII to HEX conversion table below is for use with the command/response table.

ASCII to HEX Conversion Table										Esc 1B	CR 0D	LF 0A		
Space 20	!	21	"	22	#	23	\$	24	%	25	&	26	'	27
(28)	29	*	2A	+	2B	,	2C	-	2D	.	2E	/	2F
0 30	1	31	2	32	3	33	4	34	5	35	6	36	7	37
8 38	9	39	:	3A	;	3B	<	3C	=	3D	>	3E	?	3F
@ 40	A	41	B	42	C	43	D	44	E	45	F	46	G	47
H 48	I	49	J	4A	K	4B	L	4C	M	4D	N	4E	O	4F
P 50	Q	51	R	52	S	53	T	54	U	55	V	56	W	57
X 58	Y	59	Z	5A	[5B	\	5C]	5D	^	5E	_	5F
` 60	a	61	b	62	c	63	d	64	e	65	f	66	g	67
h 68	i	69	j	6A	k	6B	l	6C	m	6D	n	6E	o	6F
p 70	q	71	r	72	s	73	t	74	u	75	v	76	w	77
x 78	y	79	z	7A	{	7B		7C	}	7D	~	7E	DEL	7F

Command/response table for SIS commands

Command	ASCII Command (host to unit)	Response (unit to host)	Additional description
Video mute			
Mute output	1B	Blk1 ←	Blank the video output.
Unmute output	0B	Blk0 ←	Output video.
Show video mute status	B	X1 ←	Video output mute status is X1 (0 = unmuted, 1 = muted).
Output sync format			
Set output sync format	6* <u>X2</u> #	Syn <u>X2</u> ←	Set the sync format. 0 = RGBHV, 1 = RGsB.
Show output sync format	6#	X2 ←	
Output sync polarity			
Set output to sync negative	7*1#	Po11 ←	Receiver output sync (H and V for RGBHV, S for RGsB, or s for RGsB) is always negative.
Set output sync to follow the input	7*0#	Po10 ←	Output sync follows the video sync input to the D.A.
Show the sync polarity	7#	X3 ←	
Horizontal shift			
Set a horizontal position	X4 H	Hph <u>X4</u> ←	Set horizontal centering to X4.
Increment position.	+H	Hph <u>X4</u> ←	Shift the image one pixel to the right.
Decrement position	-H	Hph <u>X4</u> ←	Shift the image one pixel to the left.
Show position	H	X4 ←	

Command/response table for SIS commands (continued)

Command	ASCII Command (host to unit)	Response (unit to host)	Additional description
Vertical shift			
Set a vertical position	X4 /	Vph <u>X4</u> ←	Set vertical centering to X4.
Increment position	+/	Vph <u>X4</u> ←	Shift the image down one line.
Decrement position	-/	Vph <u>X4</u> ←	Shift the image up one line.
Show position	/	X4 ←	
Horizontal start			
Set a start position	X5)	Hst <u>X5</u> ←	Set the horizontal location of the first active pixel in the active window.
<i>Example:</i>	128)	Hst128 ←	Set pixel 128 as the first active pixel.
Increment start position	+)	Hst <u>X3</u> ←	Increase the horizontal start location value.
Decrement start position	-)	Hst <u>X5</u> ←	Decrease the vertical start location value.
Show start position)	X5 ←	
Pixel phase			
Set a pixel phase value	X6 U	Phs <u>X6</u> ←	Set the pixel phase value to X6.
<i>Example:</i>	10U	Phs10 ←	Set the pixel phase value to 10.
Increment pixel phase	+U	Phs <u>X6</u> ←	Increase pixel phase value by 1.
Decrement pixel phase	-U	Phs <u>X6</u> ←	Decrease pixel phase value by 1.
Show pixel phase	U	X6 ←	

Command/response table for SIS commands (continued)

Command	ASCII Command (host to unit)	Response (unit to host)	Additional description
Total pixels			
Set a total pixel value	11*[X7]#	Tpx[X7]↵	Set the total pixels to a specific value.
<i>Example:</i>	11*1555#	Tpx1555↵	Set the total pixel value to 1555.
Increment total pixel value	+11#	Tpx[X7]↵	Increase total pixel value by 1 pixel.
Decrement total pixel value	-11#	Tpx[X7]↵	Decrease total pixel value by 1 pixel.
Show total pixel value	11#	Tpx[X7]↵	
List sync frequency			
View input frequency	1LS	[X8][X8]↵	List the input frequency as [X8] kHz (horizontal) and [X8] Hz (vertical).
Memory presets			
Save preset	[X9],	Spr[X9]↵	Command code is a comma.
Recall preset	[X9].	Rpr[X9]↵	Command code is a period.

Command/response table for SIS commands (continued)

Command	ASCII Command (host to unit)	Response (unit to host)	Additional description
Audio input gain and attenuation			
NOTE The set gain (G) and attenuation (g) commands are case sensitive.			
Set input audio gain to + dB value	[X10]G	Aud[X12]↵	
<i>Example:</i>	2G	Aud+02.0↵	Set the input audio gain to +2 dB.
Set input audio attenuation to - dB value	[X11]g	Aud[X12]↵	
Increment level	+G	Aud[X12]↵	Increase audio level by 1.0 dB.
<i>Example:</i>	+G	Aud+03↵	Increment the audio input level from +2 dB to +3 dB.
Decrement level	-G	Aud[X12]↵	Decrease the audio level by 1.0 dB.
<i>Example:</i>	-G	Aud-09↵	Decrement audio input level from -08 dB to -9 dB.
Show input gain	G	[X12]↵	
Audio output level			
Set to consumer level	40*0#	Lv10↵	Set the DA's audio output to the consumer (-10 dBu) level.
Set to professional level	40*1#	Lv11↵	Set the DA's audio output to the professional (+4 dBu) level.
Show audio output level	40#	[X13]↵	0 = consumer, 1 = professional.

Command/response table for SIS commands (continued)

Command	ASCII Command (host to unit)	Response (unit to host)	Additional description
Audio mute			
Mute the audio	1Z	Amt1 ←↵	Silence the receiver's audio output.
Unmute the audio	0Z	Amt0 ←↵	The receiver outputs audio.
Show mute status	Z	X1 ←↵	
Auto memory			
Disable auto memory	55*0#	Img0 ←↵	
Enable auto memory	55*1#	Img1 ←↵	
Show auto memory status	55#	X1 ←↵	
Auto image			
Trigger auto image	55*2#	Img ←↵	
Front panel lock (Executive mode)			
Lock the front panel	1X	Exe1 ←↵	
Unlock the front panel	0X	Exe0 ←↵	
Show the panel lock status	X	X1 ←↵	

Command/response table for SIS commands (continued)

Command	ASCII Command (host to unit)	Response (unit to host)	Additional description
Test pattern			
NOTE You must have a video input connected and fiber cable Optical 1 connected between the DA and receiver for the receiver to output a selected test pattern. The test pattern turns off if the input signal rate is changed or disconnected or if power is removed.			
Output Color Bars	1J	Tst1 ←↵	Set the receiver to output the Color Bars test pattern.
Output grayscale	2J	Tst2 ←↵	Set the receiver to output the grayscale test pattern.
Output alt. pixels	3J	Tst3 ←↵	Set the receiver to output the alternating pixels test pattern.
Test pattern off	0J	Tst0 ←↵	Set the receiver to output the input video (no test pattern selected).
Show test pattern status	J	X14 ←↵	

Command/response table for SIS commands (continued)

Command	ASCII Command (host to unit)	Response (unit to host)	Additional description
Information requests			
Information request	I	1Link[X16]•2Link[X16]•RGB[X16]•Aud[X16]•[X17]•[X18]←←	The unit responds with the current status (signal detected) of optical link 1, optical link 2, the video input, the audio input, the fiber optic mode (singlemode or multimode), and the device type (Tx or Rx).
NOTE The master receiver monitors the fiber 1 cable. If the PC is connected to the DA and fiber cable 2 is not installed between the DA and the master receiver, for the information request (I) and Status commands (S) below, the DA reports 1Link0 regardless of the status of the fiber 1 cable.			
Show firmware version	Q	[X15]←←	The factory-installed FOX 500 controller firmware version is 1.23 (sample value only).
Example:	Q	1.23←←	
Request part number	N	60- <i>mm-<i>mm</i></i> ←←	See appendix A for part numbers.
Show link 1 status	1S	[X16]←←	0 = light link not received at receiver, 1 = light received.
Show link 2 status	2S	[X16]←←	0 = light link not received at DA, 1 = light received.
Show input video status	3S	[X16]←←	0 = video is not input to the DA, 1 = video is input.
Show input audio status	4S	[X16]←←	0 = audio is not input to the DA, 1 = audio is input.

Command/response table for SIS commands (continued)

Command	ASCII Command (host to unit)	Response (unit to host)	Additional description
Resets			
Reset audio gain and attenuation	[Esc]ZA←←	Zpa←←	Reset all audio settings to default (0 dB gain and consumer [-10 dB] level).
Reset presets	[Esc]ZG←←	Zpg←←	Reset (erase) all memory presets.
System reset	[Esc]ZXX←←	Zpx←←	Reset all settings to the factory defaults.

Windows®-based Program Control

The Extron FOX 500 Control Program, which communicates with the DA via the unit's rear panel Remote RS-232 port or front panel Configuration port, provides an easy way to operate the unit. You can also connect to the master receiver and communicate with the DA (if the Optical 2 cable is connected between the DA and the master receiver).

The program is compatible with Windows 2000, Windows XP, or later. Updates to this program can be downloaded from the Extron Web site (<http://www.extron.com>).

Installing the software

The program is contained on a CD-ROM. To install the software, insert the CD-ROM into the drive. The setup program should start automatically. If it does not self-start, run `Launch.exe` from the CD and follow the instructions that appear on the screen. By default, the Windows installation creates a `C:\Program Files\Extron\FOX500` directory, and it places four icons into a group folder named "Extron Electronics\FOX 500." The four installed icons are:

- FOX 500 Control Pgm
- Check for FOX 500 updates
- Uninstall FOX 500
- FOX 500 Help

Starting the program

Start the Extron FOX 500 Control Program as follows:

1. Click **Start > Programs > Extron Electronics > FOX 500 > FOX 500 Control Pgm.**

The Communication Setup window appears (figure 3-3).

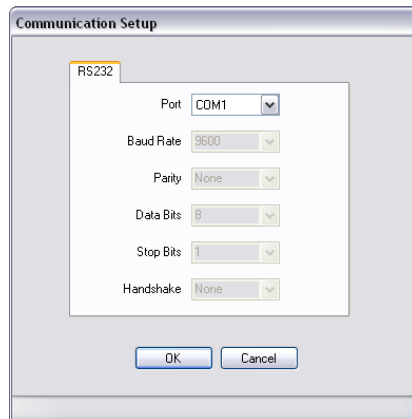

Figure 3-3 — Communication Setup window

2. Select the Com port to which your DA or receiver is connected. Click **OK.**

The FOX 500 Control Program window appears (figure 3-4).

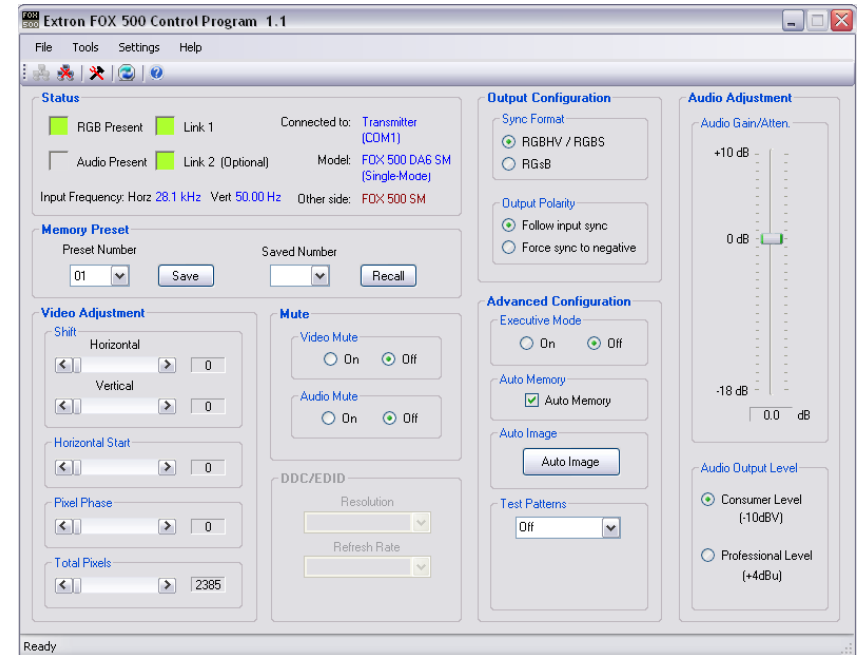

Figure 3-4 — FOX 500 Control Program window

NOTE Only one fiber optic cable, Optical 1, is required for video, audio, and serial command transmission. But, if you connect only one fiber optic cable, you do **not** receive RS-232 communications from the controlled device connected to the master receiver, and there is **reduced** RS-232 command and Windows control program functionality on the receiver. To receive responses from the master receiver and for full functionality, you must install both fiber optic cables between the DA and the master receiver.

Status area

The status area provides visual indications of the connection status. These indications are similar to the front panel indications described in chapter 2, "Installation and Operation".

- **RGB present indicator** — This indicator is green when the DA detects a sync signal on its video input:
 - Horizontal sync (H) (for RGBHV video)
 - Composite sync (S) (for RGBS video)
 - Green (Sync on green) (G) (for RGSB or RsGsBs video)
- **Audio present indicator** — This indicator is green when the DA detects a low level audio signal for a short period of time. This indicator goes dark if the audio signal drops below the minimum threshold for a short period of time.

Link 1 indicator — This indicator is green when the receiver detects light on the fiber optic cable Optical 1.

NOTE *The master receiver detects the Optical 1 light. It reports the status to the DA via the optional Optical 2 cable connected to output 1.*

*If your computer is connected to either of the DA's serial ports, **and** the Optical 2 cable is not connected in your system, the control program's Link 1 indicator does **not** show green (detected), whether the receiver detects the link or not.*

Link 2 indicator — This indicator is green when the DA detects light on the fiber optic cable Optical 2.

The Status area also shows to which unit the controlling PC is connected, the FOX 500 model (multimode or singlemode), and the video input frequency.

Memory Preset area

The Memory Preset area provides a means to save and recall memory presets. Memory presets are saved values of the horizontal and vertical position and sizing information. See the *FOX 500 User's Manual*, for more information on presets.

Mute area

Click the **Video Mute** and/or **Audio Mute** radio buttons in the Mute area to turn the video and/or audio mutes on and off.

NOTE *When the video output is muted, the receivers mute the red, green, and blue planes, but leave the horizontal and vertical or composite sync plane(s) live so that there is no loss of sync in the display device.*

NOTE *When you mute or unmute the output, the setting is changed in the receivers. The master receiver reports the changes via the optional Optical 2 cable connected between the DA and the master receiver.*

*If your computer is connected to either of the DA's serial ports, **and** the Optical 2 cable is not connected between the master receiver and the DA in your system, you **can** still mute the outputs in the control program's Mute area, but the program **cannot** report the position values. The Set video (or audio) mute On or Off message is displayed for approximately 1 second (figure 3-5).*

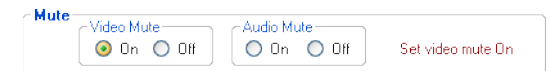

Figure 3-5 — Alternate Mute area indication

Video Adjustment area

The Video Adjustment area provides slider controls that let you change the following video parameters:

- Horizontal shift (position)
- Vertical shift (position)
- Horizontal start
- Pixel Phase
- Total pixels

NOTE When you make horizontal or vertical position changes (shift the image), the setting is changed in the receiver(s). The master receiver reports the shift values to the DA via the optional Optical 2 cable connected between the DA and the master receiver.

If your computer is connected to either of the DA's serial ports, **and** the Optical 2 cable is not connected between the master receiver and the DA in your system, you **can** still shift the image in the control program's Video Adjustment area, but the program **cannot** report the position values.

Output Configuration area

Sync Format radio buttons — Click either the **RGBHV/RGBS** or the **RGsB** radio button to select the desired video output sync format.

Output Polarity radio buttons — Click either the **Follow input sync** or the **Force sync to negative** radio button to select the desired video output sync polarity.

NOTE When you make output configuration changes, the setting is changed in the receiver(s). The master receiver reports the changes to the DA via the optional Optical 2 cable connected between the DA and the master receiver.

If you are connected to either of the DA's serial ports, **and** the Optical 2 cable is not connected between the master receiver and the DA in your system, the program **cannot** report the output sync format and polarity position settings in the control program's Video Adjustment area. You **can** change the output sync format and polarity, but the program **cannot** report the changes.

Advanced Configuration area

Executive Mode button — Click the **Executive Mode** radio button to toggle the front panel lock on and off.

NOTE When you toggle the front panel lock on and off, the setting is changed in the receiver(s). The master receiver reports the changes to the DA via the optional Optical 2 cable connected between the DA and the master receiver.

If your computer is connected to either of the DA's serial ports, **and** the Optical 2 cable is not connected between the master receiver and the DA in your system, you **can** still toggle the front panel lock in the control program's Advanced Configuration area, but the program **cannot** report the lock's status. The program indication changes (figure 3-6) to show that the Executive mode is control only, without and indication of the current mode. The Set executive mode On or Off message is displayed for approximately 1 second.

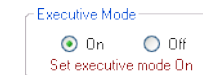

Figure 3-6 — Alternate Advanced Configuration area indication

Auto Memory checkbox — Click the **Auto Memory** checkbox to automatically apply saved position, horizontal start, total pixels, and pixel phase settings when the sensed input resolution changes. See "Auto Memory submenu" in chapter 2, "Installation and Operation" for more details about the auto memory function.

Auto Image button — Click the **Auto Image** button to adjust the output settings for the best image, based on the sensed input resolution.

Test Patterns drop box — Select one of three built-in test patterns - **Color Bars**, **grayscale**, and **alternating pixels** - as necessary to help adjust the display's color, focus, and grayscale. Select **Off** to output the video input to the DA.

NOTE You must have a video input connected and fiber cable Optical 1 connected between the DA and receiver for the receiver to output a selected test pattern.

The test pattern turns off if the input signal rate is changed or disconnected, or if power is removed.

Audio Adjustment area

Audio Gain/Attenuation slider — Click and drag the **Audio Gain/Attenuation** slider control to select the input audio gain or attenuation value, from -18 dB to +10 dB in 1.0 dB increments.

Audio Output Level area

Audio Output Level radio buttons — Click either the **Consumer Level** (-10 dBV) or **Professional Level** (+4 dBu) radio button to select the output audio level.

NOTE When you make an audio output level change, the setting is changed in the receiver(s). The master receiver reports the changes to the DA via the optional Optical 2 cable connected between the DA and the master receiver.

If your computer is connected to either of the DA's serial ports, **and** the Optical 2 cable is not connected between the master receiver and the DA in your system, the program **cannot** report the output audio level in the control program's Audio Adjustment area. You **can** change the level, but the program **cannot** report the changes. The program shows the Set Consumer (or Professional) level message to indicate that the output level command is control only, not an indication (figure 3-7). The message is displayed for approximately 1 second.

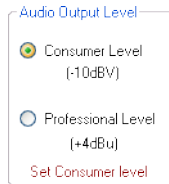

Figure 3-7 — Alternate Audio Adjustment area indication

Firmware upgrade

Firmware can be upgraded via either of the unit's serial ports by opening the Extron Firmware Loader utility from the Windows-based control program.

NOTE When firmware upgrades are available, they are unique to the unit; a DA firmware upgrade and a separate receiver upgrade for the Rx unit.

You must connect directly to the unit to be updated.

Upload replacement firmware as follows:

1. Visit the Extron web site, www.extron.com, click the **Download Center** tab, and then click the **Firmware** link (figure 3-8). Select the appropriate firmware file(s) to download and copy it (them) to your computer. Note the folder to which you save the firmware file(s).

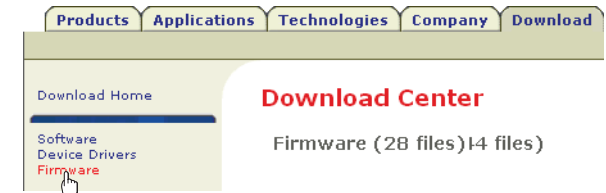

Figure 3-8 — Location of firmware upgrade files

2. In the Windows Explorer or other file browser, double-click the downloaded executable (*.exe) file(s) to self-extract the firmware file(s).
3. Connect a Windows-based computer to either serial port (rear panel Remote RS-232 or front panel Configuration) of the unit to be updated. See chapter 2, "Installation and Operation", for more details.
4. Start the FOX 500 Control Program. See "Starting the program", on page 3-16.
5. Click **Tools > Update Firmware**. The Extron Firmware Loader appears (figure 3-9).

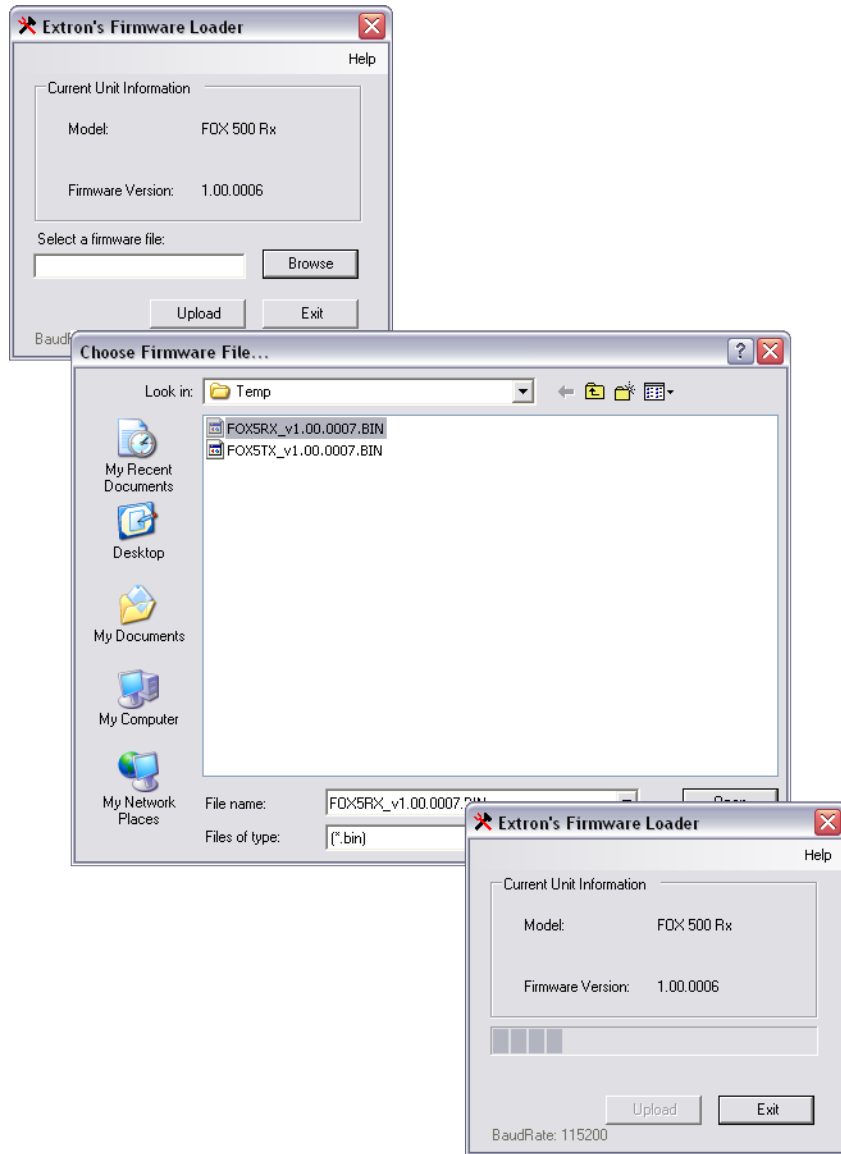

Figure 3-9 — Open window

- a. Click **Browse**. The open file window appears.
- b. Navigate to the folder where you saved the firmware upgrade file in step 1. Select the file. The Firmware Loader returns to the top.

NOTE Valid firmware files must have the file extension “.BIN”. A file with any other extension is not a firmware upgrade for your FOX 500 DA6.

- c. Click **Upload**. The File Loader reports, "This process could take several minutes. Please wait..." and then displays a scroll bar that shows the status of the upload.
 - d. When the Firmware Loader reports, "Transfer complete!", click the **Exit** button.
6. Cycle the DA unit's power.
 7. If necessary, repeat this entire procedure on receivers in the system.



A

Appendix A

Reference Information

Specifications

Part Numbers

Reference Information

Specifications

NOTE The analog RGB input signal is digitized pixel for pixel in the transmitter, sent digitally through the fiber cable, and converted back to analog RGB in the receiver.

NOTE The analog audio signal(s) is (are) digitized in the transmitter, sent through the fiber cable, and converted back to analog audio in the receiver.

Optical specifications

Number/type 6 fiber optic outputs

NOTE Only one fiber is required to transmit video, audio, and unidirectional data. A second fiber is required to transmit return data for bidirectional control/communication on receiver 1.

Connectors 6 LC connectors

Operating distance..... 30 km (18.75 miles) with singlemode (SM) cables with a FOX 500 DA6 SM
0.15 km (492') with multimode (MM) cables with a FOX 500 DA6 MM

NOTE Operating distance is approximate. These are typical distances. The maximum distance may be greater than these typical numbers depending on factors such as fiber type, fiber bandwidth, connector splicing, losses, modal or chromatic dispersion, environmental factors, and kinks.

Nominal peak wavelength..... 850 nm for FOX 500 DA6 MM,
1310 nm for FOX 500 DA6 SM

Data rate 4.25 Gbps

Transmission power

Singlemode..... -5 dBm, typical

Multimode..... -5 dBm, typical

Maximum receiver sensitivity

Singlemode..... -18 dBm, typical

Multimode..... -12 dBm, typical

Optical loss budget

Singlemode..... 13 dB, maximum

Multimode..... 7 dB, maximum

Video

Gain Unity
Pixel data bit depth..... 8 bits per channel, 3 channels (R, G, B)
Maximum resolution 1600x1200 @ 60 Hz, digitized pixel by pixel; higher resolutions up to 2048x1120, undersampled

Video input and loop-through

Number/signal type..... 1 VGA-UXGA RGBHV, RGBS, RGSB, RsGsBs input
1 VGA-UXGA RGBHV, RGBS, RGSB, RsGsBs loop-through
Connectors 1 x 5 female BNC or (1) female 15-pin HD for input
(1) female 15-pin HD for loop-through
Nominal level 0.7 Vp-p for RGB
Minimum/maximum levels..... Analog: 0.3 V to 1.5 Vp-p with no offset
Impedance 75 ohms
Horizontal frequency..... 24 kHz to 100 kHz
Vertical frequency..... 40 Hz to 120 Hz
Return loss <-40 dB @ 5 MHz

NOTE These transceivers are class 1 laser products. They meet the safety regulations of IEC-60825, FDA 21, CFR 1040.10, and FDA 21 CFR 1040.11.

Video output — See optical specifications above.

Sync

Input type Autodetect RGBHV, RGBS, RGSB, RsGsBs
Input level 2.5 V to 5.0 Vp-p
Input impedance 10k ohms
Polarity..... Positive or negative (follows input or can be set by user)

Audio

Gain

Range Adjustable, -18 dB to +10 dB
Default
Captive screw connector
Unbalanced output: -6 dB;
balanced output: 0 dB
Mini stereo jack..... Unbalanced output: 0 dB

Reference Information, cont'd

Frequency response	20 Hz to 20 kHz, ± 0.5 dB
THD + Noise	0.10% @ 1 kHz at nominal level
S/N	>80 dB at maximum output (unweighted)
CMRR	65 dB @ 20 Hz to 20 kHz
Audio bits per sample	18 bits per channel, 2 channels (L, R)
Sampling rate.....	48 kHz

Audio input

Number/signal type	2 inputs (mixed): 1 balanced stereo; 1 unbalanced stereo or 2 unbalanced mono
Connectors	(1) 3.5 mm captive screw connector, 5 pole (1) 3.5 mm mini stereo jack
Impedance	18k ohms unbalanced, 20k ohms balanced, DC coupled
Nominal level	+4 dBu (1.23 Vrms), -10 dBV (316 mVrms)
Maximum level	+17 dBV, (unbalanced) at 1% THD+N

NOTE $0 \text{ dBu} = 0.775 \text{ Vrms}$, $0 \text{ dBV} = 1 \text{ Vrms}$, $0 \text{ dBV} \approx 2 \text{ dBu}$

Audio output — See FOX 500 Rx receiver specifications.

Control/remote

Serial control ports	
Control.....	1 RS-232, 3.5 mm captive screw connector, 5 pole (3 pins are used) (rear panel) 1 RS-232, 2.5 mm mini stereo jack (front panel)
Pass-through.....	1 RS-232, 3.5 mm captive screw connector, 5 pole (3 pins are used) (rear panel); in parallel with 1 RS-232, 2.5 mm mini stereo jack (front panel)
Baud rate and protocol	
Control.....	9600 baud, 8 data bits, 1 stop bit, no parity
Pass-through.....	9600 to 38400 baud
Serial control pin configurations	
Captive screw connectors: 1 = Tx, 2 = Rx, 3 = GND	
Mini stereo jack: tip = Tx, ring = Rx, sleeve = GND	
Program control.....	Extron's control/configuration program for Windows® Extron's Simple Instruction Set (SIS™)

General

Power	100 VAC to 240 VAC, 50/60 Hz, 11 watts, internal
Temperature/humidity.....	Storage: -40 to +158 °F (-40 to +70 °C) / 10% to 90%, noncondensing Operating: +32 to +122 °F (0 to +50 °C) / 10% to 90%, noncondensing
Cooling	Convection, vented, vents on top and side panels
Rack mount.....	Yes, with included brackets
Enclosure type	Metal
Enclosure dimensions	1.7" H x 17.4" W x 9.5" D (1U high, full rack wide) 4.3 cm H x 44.2 cm W x 24.1 cm D (Depth excludes connectors.)
Product weight.....	3.9 lbs (1.8 kg)
Shipping weight	7 lbs (4 kg)
DIM weight	
USA/Canada.....	7 lbs (4 kg)
International.....	8 lbs (4 kg)
Vibration	ISTA 1A in carton (International Safe Transit Association)
Listings.....	UL, CUL
Compliances.....	CE, FCC Class A, VCCI, AS/NZS, ICES, FDA Class 1
MTBF.....	30,000 hours
Warranty	3 years parts and labor

NOTE *All nominal levels are at $\pm 10\%$.*

NOTE *Specifications are subject to change without notice.*

Reference Information, cont'd

Part Numbers

FOX 500 DA6 part numbers

The FOX 500 DA6 is available in a singlemode (SM) and a multimode (MM) model:

FOX 500 Models	Part number
FOX 500 DA6 SM	60-863-02
FOX 500 DA6 MM	60-863-01

Included parts

These items are included in each order for a FOX 500 DA6:

Included parts	Part number
IEC power cord	
Tweezer (small screwdriver)	
User's manual	
Extron Software Products CD (FOX 500 Control Program)	
Captive screw 5-pole connectors (qty. 6)	10-703-12
(1) 10' LC-LC duplex patch cables (SM or MM, depending on the model)	

Compatible equipment

The FOX 500 DA6 is compatible with a variety of Extron fiber optic receivers and matrix switchers, as shown below:

FOX 500 (RGB Video) receivers	Part number
FOX 500 Rx SM	60-746-22
FOX 500 Rx MM	60-746-21

FOX 500 DVI models	Part number
FOX 500 DVI Rx SM	60-859-22
FOX 500 DVI Rx MM	60-859-21

Fiber Matrix 6400 matrix switcher	Part number
Fiber Matrix 6400 BME	60-878-01
Singlemode I/O card	60-879-02

Fiber Matrix 6400 matrix switcher	Part number
Multimode I/O card	60-879-01

Optional accessory

Accessories	Part number
9-pin D to 2.5 mm mini jack TRS RS-232 cable	70-335-01

Cables

Accessories	Part number
VGA M-M MD, 3' to 100' (0.9 m to 30.4 m) (molded)	26-238- <i>nn</i>
VGA M-M BK, 3' to 100' (0.9 m to 30.4 m) (backshell)	26-238- <i>nn</i>
VGAP M-M MD, 3' to 25' (0.9 m to 7.6 m) (molded)	26-439- <i>nn</i>
VGAP M-M BK, 35' to 100' (10.6 m to 30.4 m) (backshell)	26-439- <i>nn</i>
VGA-A M-M MD (with audio), 3' to 50' (0.9 m to 15.2 m) (molded)	26-490- <i>nn</i>
VGA-A M-M BK (with audio), 3' to 50' (0.9 m to 15.2 m) (backshell)	26-490- <i>nn</i>
MHR-5 BNC mini high resolution male to male, 3' to 100' (0.9 m to 30.4 m)	26-260- <i>nn</i>
MHR-5P BNC mini high resolution plenum male to male, 3' to 100' (0.9 m to 30.4 m)	26-378- <i>nn</i>
M59-5 BNC mini 59 flex male to male, 3' to 100' (0.9 m to 30.4 m)	26-499- <i>nn</i>
RG6-5 BNC super high resolution male to male, 3' to 100' (0.9 m to 30.4 m)	26-369- <i>nn</i>

